

Double Trim Nozzles



Double Trim Nozzles deliver two high pressure, high impact trim jets for the ultimate in quality edge trimming.

Gateway double trim nozzles are available in parallel stream or 10 degree angles. They are available with stainless steel or ruby orifice tips.

Ruby Tips - Double 10° Stream & Parallel Stream

Double 10° Stream Ruby Tip in Stainless Steel Shell with Teflon® Drip Shield



Size	Part #
.010" x 2"	RD1046SS
.015" x 2"	RD1546SS
.020" x 2"	RD2046SS
.025" x 2"	RD2546SS
.030" x 2"	RD3046SS
.035" x 2"	RD3546SS
.040" x 2"	RD4046SS
.050" x 2"	RD5046SS

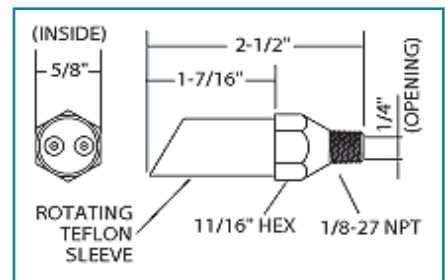

Double Parallel Stream Ruby Tip in Stainless Steel Shell with Teflon® Drip Shield



Size	Part #
.010"	R-PRL1047SS
.015"	R-PRL1547SS
.020"	R-PRL2047SS
.025"	R-PRL2547SS
.030"	R-PRL3047SS
.035"	R-PRL3547SS
.040"	R-PRL4047SS
.050"	R-PRL5047SS

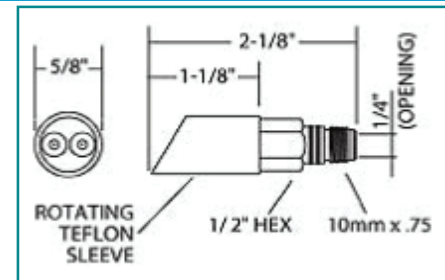

Double Parallel Stream Ruby Tip in Stainless Steel Shell with Stainless Steel Drip Shield



Size	Part #
.010"	RS-PRL109MSS
.015"	RS-PRL159MSS
.020"	RS-PRL209MSS
.025"	RS-PRL259MSS
.030"	RS-PRL309MSS
.035"	RS-PRL359MSS
.040"	RS-PRL409MSS
.045"	RS-PRL459MSS

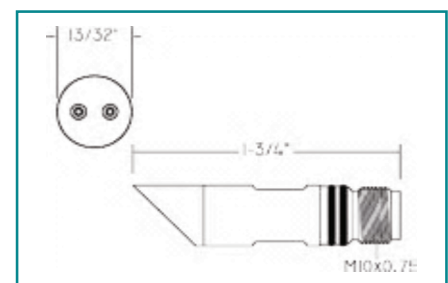

Double Parallel Stream Ruby Tip in Adjustable Stainless Steel Shell with Stainless Steel Drip Shield



Size	Part #
.010"	RA-PRL109MSS
.015"	RA-PRL159MSS
.020"	RA-PRL209MSS
.025"	RA-PRL259MSS
.030"	RA-PRL309MSS
.035"	RA-PRL359MSS
.040"	RA-PRL409MSS
.045"	RA-PRL459MSS

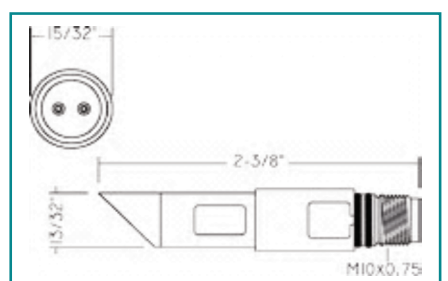

Note: 1/8 NPT is available on request. Also available with anti-stick Teflon® Coating. Any combination of sizes are available.

Stainless Steel Tips - Double 10° Stream & Parallel

Double Stainless Tips in Brass Long Shell



Size	10° Stream	Parallel Stream
.010" x 2"	D105	PRL105
.012" x 2"	D125	PRL125
.015" x 2"	D155	PRL155
.018" x 2"	D185	PRL185
.020" x 2"	D205	PRL205
.023" x 2"	D235	PRL235
.025" x 2"	D255	PRL255
.015" x .020"	D15205	PRL15205

Any Combination of Sizes are Available

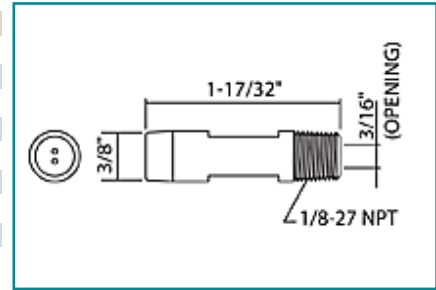

Double Stainless Tips in Stainless Steel Short High Pressure Hex Shell



Size	10° Stream	Parallel Stream
.010" x 2"	D108SS	PRL108SS
.012" x 2"	D128SS	PRL128SS
.015" x 2"	D158SS	PRL158SS
.018" x 2"	D188SS	PRL188SS
.020" x 2"	D208SS	PRL208SS
.023" x 2"	D238SS	PRL238SS
.025" x 2"	D258SS	PRL258SS
.015" x .020"	D15208SS	PRL15208SS

Any Combination of Sizes are Available

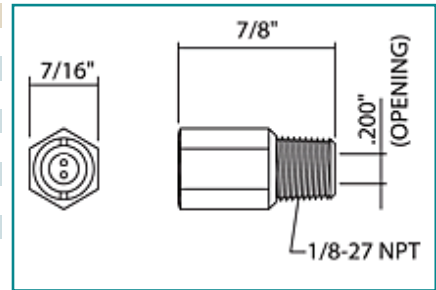

Double Stainless Tips in Stainless Steel Long High Pressure Shell



Size	10° Stream	Parallel Stream
.010" x 2"	D1011SS	PRL1011SS
.012" x 2"	D1211SS	PRL1211SS
.015" x 2"	D1511SS	PRL1511SS
.018" x 2"	D1811SS	PRL1811SS
.020" x 2"	D2011SS	PRL2011SS
.023" x 2"	D2311SS	PRL2311SS
.025" x 2"	D2511SS	PRL2511SS
.015" x .020"	D152011SS	PRL152011SS

Any Combination of Sizes are Available

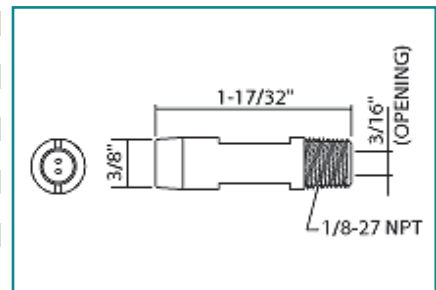

Double 10° Stream

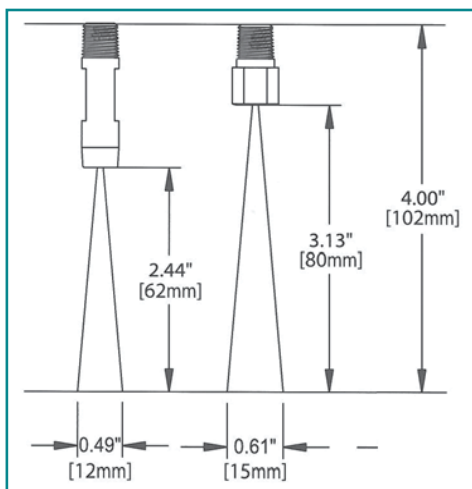

Parallel Stream

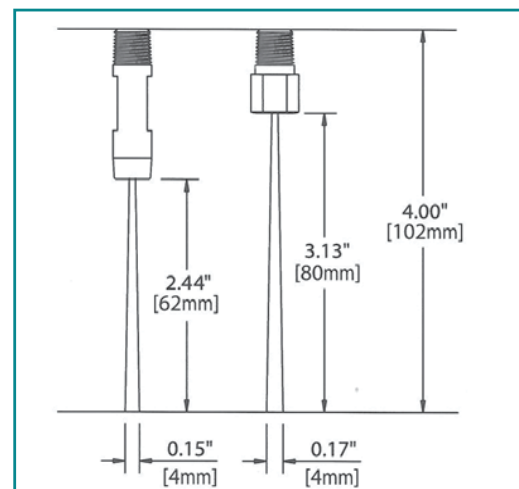

Thread Adapters, Filter Screens & Accessories

Leaders in Needle Jet Nozzles for the Paper Industry

We are continuously striving to provide the best technology in our designs. Our research and development is an on-going process. In addition, we provide a wide range of accessories to compliment your nozzles. If your trim nozzle application requires special accessories - contact us.

Thread Adapters



Part #	Description
M10FSS	10mm x 0.75 Female to 1/8 NPT Male Stainless Steel Note: Adapts Gatewood Double Parallel Stream Ruby Nozzle to 1/8 NPT Male
M10MSS	1/8 NPT Female to 10mm x .75 Male Stainless Steel Note: Adapts All Gatewood 1/8 NPT Nozzles to 10mm x 0.75 Female

Filter Screen with Stainless Bushing



Size	Part #
40 Mesh	SA64
50 Mesh	SA65
60 Mesh	SA66
100 Mesh	SA6100R
40 Mesh BSPT	SA74
50 Mesh BSPT	SA75
60 Mesh BSPT	SA76
100 Mesh BSPT	SA7100R

Shown with Standard Screen

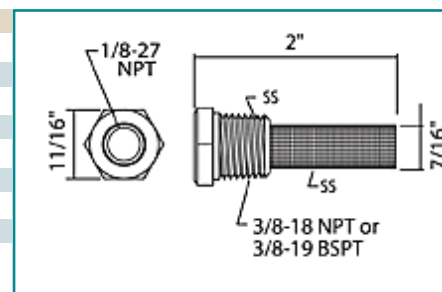

Filter Screen with Brass Bushing



Size	Part #
40 Mesh	A64
50 Mesh	A65
60 Mesh	A66
100 Mesh	A6100R
40 Mesh BSPT	A74
50 Mesh BSPT	A75
60 Mesh BSPT	A76
100 Mesh BSPT	A7100R

Shown with Standard Screen

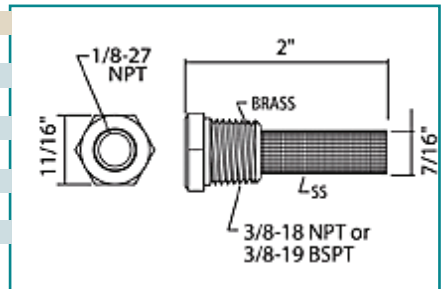

Other Screen Options

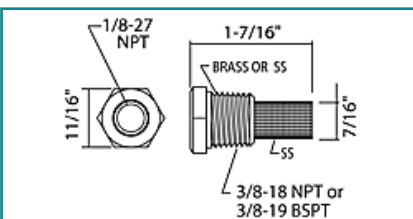

Short Screen

Size	Brass	SS
50 Mesh	A65SHRT	SA65SHRT

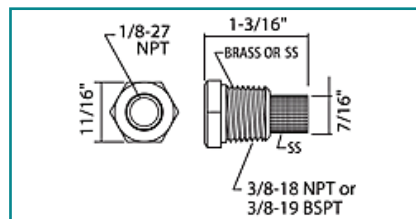

Extra Short Screen

Size	Brass	SS
50 Mesh	A65SHSH	SA65SHSH

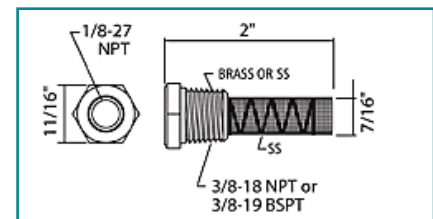

Extra Short Screen

Size	Brass	SS
40 Mesh	A64R	SA64R
50 Mesh	A65R	SA65R
60 Mesh	A66R	SA66R
100 Mesh	A6100R	SA6100R
200 Mesh	A6200R	SA6200R

Double Trim